

Artec Ray II

User Manual



Version 1.1



Introduction

Purchase

Congratulations on the purchase of an Artec Ray II scanner.



This manual contains important safety directions as well as instructions for setting up the product and operating it. Refer to [1 Safety Directions](#) for further information.

Read carefully through the User Manual before you switch on the product.

To ensure safety when using accompanying battery charger, also observe the directions and instructions contained in the User Manual of the battery charger.



The content of this document is subject to change without prior notice. Ensure that the product is used in accordance with the latest version of this document.

Product identification

The model and serial number of your product are indicated on the type label. Always refer to this information when contacting [Artec 3D Support Team](#) or Authorized Reseller.

Trademarks

Windows® is a registered trademark of Microsoft Corporation in the United States and other countries.

All other trademarks are the property of their respective owners.

Customer support

If you have any question regarding the use of Artec Ray II, refer to the [Artec 3D Support Team](#) or fill out the question form available [here](#).

Available documentation

Name	Description/Format
Artec Ray II User Manual	All instructions required in order to operate the product to a basic level are contained in the User Manual. Provides an overview of the product together with technical data and safety directions.
Artec Ray II Quick Start Guide	A brief overview of the product, including its technical specifications and the essential steps required to begin using it.
Artec Ray II Check and Adjust User Manual	All instructions required to perform checking the current angular accuracy of the scanner and make adjustments if needed.
Artec Multicharger User Manual	All instructions and safety directions regarding the use of the Multicharger for Artec Ray II.

1 Safety Directions

1.1 General Introduction

Description

The following directions enable the person responsible for the product, and the person who actually uses the equipment, to anticipate and avoid operational hazards.

The person responsible for the product must ensure that all users understand these directions and adhere to them.

Warning messages





Warning messages are an essential part of the safety concept of the scanner. They appear wherever hazards or hazardous situations can occur.

Warning messages

- Make the user alert about direct and indirect hazards concerning the use of the product.
- Contain general rules of behaviour.

For the users' safety, all safety instructions and safety messages shall be strictly observed and followed! Therefore, the manual must always be available to all persons performing any tasks described here.

DANGER, WARNING, CAUTION and **NOTICE** are standardised signal words for identifying levels of hazards and risks related to personal injury and property damage. For your safety, it is important to read and fully understand the following table with the different signal words and their definitions! Supplementary safety information symbols may be placed within a warning message as well as supplementary text.

Type	Description
 DANGER	Indicates an imminently hazardous situation which, if not avoided, will result in death or serious injury.
 WARNING	Indicates a potentially hazardous situation or an unintended use which, if not avoided, could result in death or serious injury.
 CAUTION	Indicates a potentially hazardous situation or an unintended use which, if not avoided, may result in minor or moderate injury.
NOTICE	Indicates a potentially hazardous situation or an unintended use which, if not avoided, may result in appreciable material, financial and environmental damage.
	Important paragraphs which must be adhered to in practice as they enable the product to be used in a technically correct and efficient manner.

1.2 Definition of Use

Intended use

- Measuring horizontal and vertical angles
- Measuring distances
- Scanning objects
- Capturing and recording images
- Recording measurements
- Computing with software
- Remote control of product
- Data communication with external appliances

1.2 Definition of Use

Reasonably foreseeable misuse

Use of the product without instructions
Use outside of the intended use and limits
Disabling of safety systems
Removal of hazard notices
Opening the product using tools, for example a screwdriver, unless this is permitted for certain functions
Modification or conversion of the product
Use after misappropriation
Use of products with recognisable damage or defects
Use with accessories from other manufacturers without the prior explicit approval of Artec 3D
Inadequate safeguards at the working site
Deliberate dazzling of third parties

1.3 Limits of Use

Environment

Suitable for use in an atmosphere appropriate for permanent human habitation. Not suitable for use in aggressive or explosive environments.

 **WARNING**

Working in hazardous areas or close to electrical installations or similar situations is a life risk.

Precautions:

- Local safety authorities and safety experts must be contacted by the person responsible for the product before working in such conditions.



The following advice is only valid for Power supply and Multicharger.

Environment

Suitable for use in dry environments only and not under adverse conditions.



1.4 Responsibilities

Manufacturer of the product

Artec 3D (manufacturer) 11 Breedewues, L-1259 Senningerberg, Luxembourg, hereinafter referred to as Artec 3D, is responsible for supplying the product, including the User Manual, other manuals listed in the Introduction, and original accessories, in a safe condition.

1.4 Responsibilities

Person responsible for the product

The person responsible for the product has the following duties:

- To understand the safety instructions on the product and the instructions in the User Manual
- To ensure that the product is used in accordance with the instructions
- To be familiar with local regulations relating to safety and accident prevention
- To stop operating the system and inform Artec 3D immediately if the product and the application become unsafe
- To ensure that the national laws, regulations and conditions for the operation of the products are respected.

1.5 Hazards of Use

WARNING

Distraction or loss of attention

During dynamic applications there is a danger of accidents occurring if the user does not pay attention to the environmental conditions around, for example obstacles, excavations or traffic.

Precautions:

- The person responsible for the product must make all users fully aware of the existing dangers.

WARNING

Inadequate securing of the working site

This can lead to dangerous situations, for example in traffic, on building sites and at industrial installations.

Precautions:

- Always ensure that the working site is adequately secured.
- Adhere to the regulations governing safety, accident prevention and road traffic.

NOTICE

Dropping, misusing, modifying, storing the product for long periods or transporting the product

Watch out for erroneous measurement results.

Precautions:

- Periodically carry out test measurements, particularly after the product has been subjected to abnormal use and before and after important measurements.

WARNING

Moving parts at the product during operation

Risk of squeezing extremities or entanglement of hair and/or clothes.

Precautions:

- Keep a safe distance to the moving parts.



1.5 Hazards of Use



If the scanner moves unexpectedly during operation, stop the scanner via user interface (display, key) or alternatively remove the battery or main power source to prevent further movements.

CAUTION

Not properly secured accessories

If the accessories used with the product are not properly secured and the product is subjected to mechanical shock, for example blows or falling, the product may be damaged or people can sustain injury.

Precautions:

- When setting up the product, make sure that the accessories are correctly adapted, fitted, secured, and locked in position.
- Avoid subjecting the product to mechanical stress.

WARNING

Exposure of batteries to high mechanical stress, high ambient temperatures or immersion into fluids

This can cause leakage, fire or explosion of the batteries.

Precautions:

- Protect the batteries from mechanical influences and high ambient temperatures. Do not drop or immerse batteries into fluids.

WARNING

Short circuit of battery terminals

If battery terminals are short circuited e.g. by coming in contact with jewellery, keys, metallised paper or other metals, the battery can overheat and cause injury or fire, for example by storing or transporting in pockets.

Precautions:

- Make sure that the battery terminals do not come into contact with metallic/ conductive objects.

WARNING

Inappropriate mechanical influences to batteries

During the transport, shipping or disposal of batteries it is possible for inappropriate mechanical influences to constitute a fire hazard.

Precautions:

- Before shipping the product or disposing it, discharge the batteries by the product until they are flat.
- When transporting or shipping batteries, the person in charge of the product must ensure that the applicable national and international rules and regulations are observed.
- Before transportation or shipping, contact your local passenger or freight transport company.

1.5 Hazards of Use

WARNING

Overheating hazard

If the ventilation slots are covered while the product is being used, the product can overheat and cause injury or fire.

Precautions:

- Make sure that the ventilation slots are not covered by any objects while the product is being used.

WARNING

If the product is improperly disposed of, the following can happen:

- If polymer parts are burnt, poisonous gases are produced which may impair health.
- If batteries are damaged or are heated strongly, they can explode and cause poisoning, burning, corrosion or environmental contamination.
- By disposing of the product irresponsibly you may enable unauthorised persons to use it in contravention of the regulations, exposing themselves and third parties to the risk of severe injury and rendering the environment liable to contamination.
- The product includes parts of Beryllium inside. Any modification of some internal parts can release dust or fragments, creating health hazard.

Precautions:

- The product must not be disposed with household waste. Dispose of the product appropriately in accordance with the national regulations in force in your country. Always prevent access to the product by unauthorised personnel.

Product-specific treatment and waste management information can be received from Artec 3D or Authorized reseller.

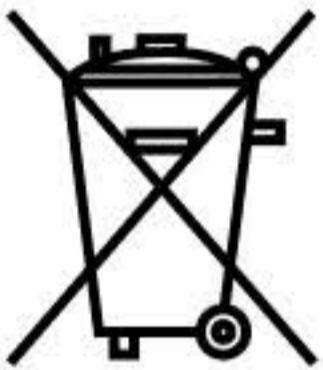

Applies only for California. The product contains CR Lithium Cell(s) with perchlorate material inside – special handling may apply. Refer to [Department of Toxic Substances Control - Perchlorate](#) for more details.

WARNING

Lightning strike

If the product is used with accessories, for example masts, staffs, poles, you may increase the risk of being struck by lightning.

Precautions:

- Do not use the product in a thunderstorm.

WARNING

Improperly repaired equipment

Risk of injuries to users and equipment destruction due to lack of repair knowledge.

Precautions:

- Only authorized Artec 3D Service Centers are entitled to repair these products.

1.5 Hazards of Use

WARNING

Unauthorised opening of the product

Either of the following actions may cause you to receive an electric shock:

- Touching live components
- Using the product after incorrect attempts were made to carry out repairs

Precautions:

- Do not open the product!
- Only authorized Artec 3D Service Centers are entitled to repair these products.

WARNING

Electric shock due to use under wet and severe conditions

If unit becomes wet, it may cause you to receive an electric shock.

Precautions:

- If the product becomes humid, it must not be used!
- Use the product only in dry environments, for example in buildings or vehicles.



- Protect the product against humidity.

WARNING

Electric shock due to missing ground connection

If unit is not connected to ground, death or serious injury can occur.

Precautions:

- The power cable and power outlet must be grounded!



1.6 Laser Classification

1.6.1 General

General

The following chapters provide instructions and training information about laser safety according to international standard IEC 60825-1 (2014-05) and technical report IEC TR 60825-14 (2004-02). The information enables the person responsible for the product and the person who actually uses the equipment, to anticipate and avoid operational hazards.



According to IEC TR 60825-14 (2004-02), products classified as laser class 1, class 2 and class 3R do not require:

- laser safety officer involvement
- protective clothes and eyewear
- special warning signs in the laser working area

if used and operated as defined in this User Manual due to the low eye hazard level.



National laws and local regulations could impose more stringent instructions for the safe use of lasers than IEC 60825-1 (2014-05) and IEC TR 60825-14 (2004-02).

1.6.2 Scanning Laser

General

The laser incorporated in the product produces an invisible beam, which emerges from the rotating mirror.

The laser product described in this section is classified as laser class 1 in accordance with:

- IEC 60825-1 (2014-05): "Safety of laser products"

These products are safe under reasonably foreseeable conditions of operation and are not harmful to the eyes provided that the products are used and maintained in accordance with this User Manual.

Description	Artec Ray II
Wavelength	1550 nm
Maximum pulse energy	1.5 μ J
Pulse duration	0.5 ns
Maximum pulse repetition frequency (PRF)	2 MHz
Beam divergence (1/e ² , full angle)	0.5 mrad
Mirror rotation	100 Hz
Minimal base rotation speed	5 mHz

1.6.2 Scanning Laser

Labelling

Artec Ray II

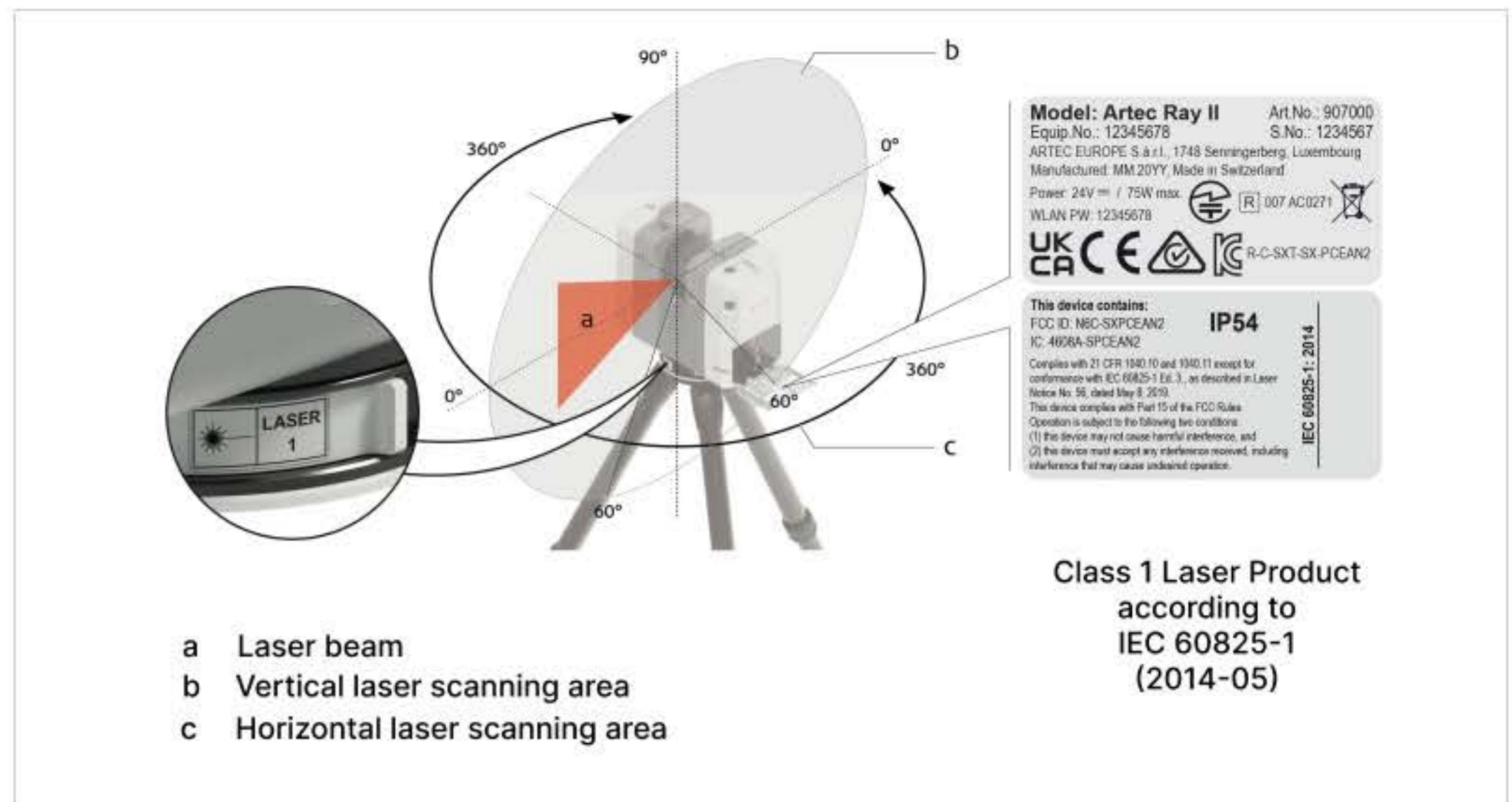

1.7 Electromagnetic Compatibility (EMC)

Description

The term Electromagnetic Compatibility is taken to mean the capability of the product to function smoothly in an environment where electromagnetic radiation and electrostatic discharges are present, and without causing electromagnetic disturbances to other equipment.

⚠ CAUTION

Electromagnetic radiation

Electromagnetic radiation can cause disturbances in other equipment.

Precautions:

- Although the product meets the strict regulations and standards which are in force in this respect, Artec 3D cannot completely exclude the possibility that other equipment may be disturbed.
- The product is a class A product when operated with WLAN and powered by the external power supply. In a domestic environment this product may cause radio interference in which case the user may be required to take adequate measures.

⚠ CAUTION

Use of the product with accessories from other manufacturers. For example, field computers, personal computers or other electronic equipment, non-standard cables or external batteries

This may cause disturbances in other equipment.

Precautions:

- Use only the equipment and accessories recommended by Artec 3D.
- When combined with the product, other accessories must meet the strict requirements stipulated by the guidelines and standards.
- When using computers, two-way radios or other electronic equipment, pay attention to the information about electromagnetic compatibility provided by the manufacturer.

1.7 Electromagnetic Compatibility (EMC)

CAUTION

Intense electromagnetic radiation. For example, near radio transmitters, transponders, two-way radios or diesel generators

Although the product meets the strict regulations and standards which are in force in this respect, Artec 3D cannot completely exclude the possibility that the function of the product may be disturbed in such an electromagnetic environment.

Precautions:

- Check the plausibility of results obtained under these conditions.

CAUTION

Electromagnetic radiation due to improper connection of cables

If the product is operated with connecting cables, attached at only one of their two ends, the permitted level of electromagnetic radiation may be exceeded and the correct functioning of other products may be impaired. For example, external supply cables or interface cables.

Precautions:

- While the product is in use, connecting cables, for example product to external battery or product to computer, must be connected at both ends.

WARNING

Use of product with radio or digital cellular phone devices

Electromagnetic fields can cause disturbances in other equipment, installations, medical devices, for example pacemakers or hearing aids, and aircrafts. Electromagnetic fields can also affect humans and animals.

Precautions:

- Although the product meets the strict regulations and standards which are in force in this respect, Artec 3D cannot completely exclude the possibility that other equipment can be disturbed or that humans or animals can be affected.
- Do not operate the product with radio or digital cellular phone devices in the vicinity of filling stations or chemical installations, or in other areas where an explosion hazard exists.
- Do not operate the product with radio or digital cellular phone devices near medical equipment.
- Do not operate the product with radio or digital cellular phone devices in aircrafts.
- Do not operate the product with radio or digital cellular phone devices for long periods with the product immediately next to your body.

2 User Interface

2.1 Power Button

Power button

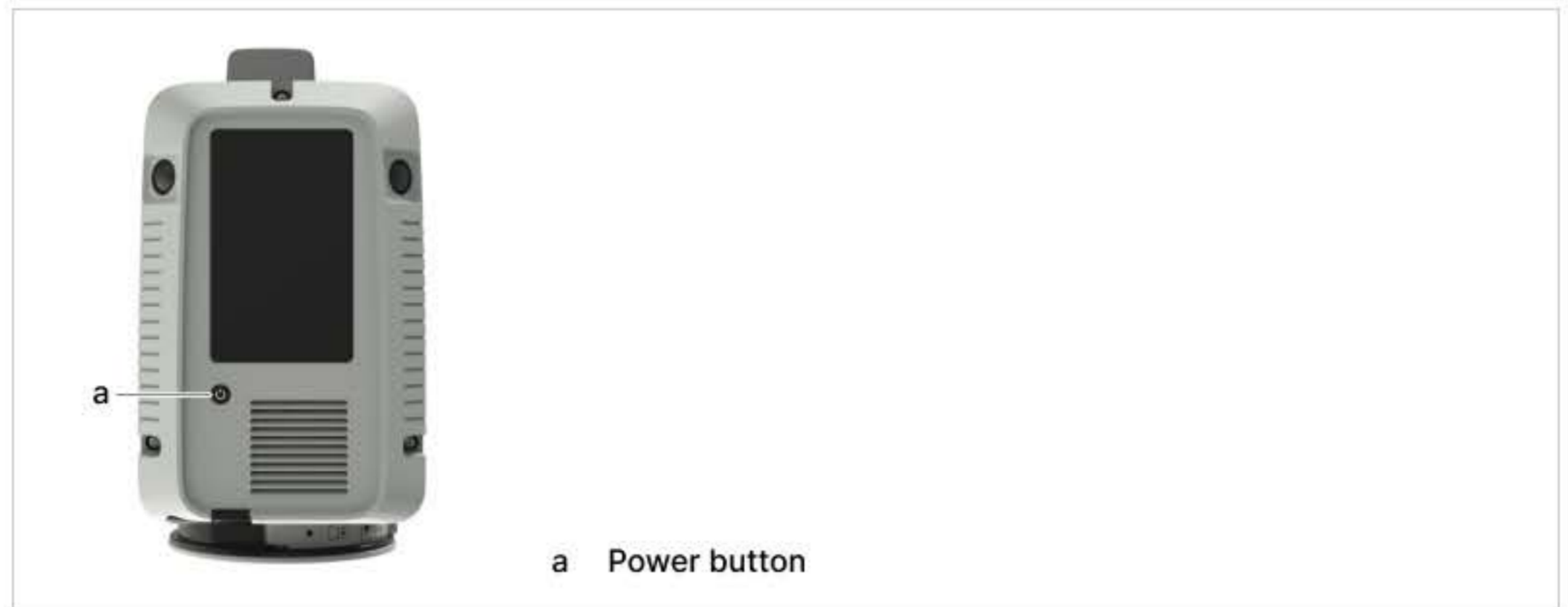





Power button	Scanner state before action	Result
Press and hold the button 1 sec.	off	The scanner switches on and the Power button starts blinking yellow.
Press and hold the button 1 sec.	on and ready	The Power button starts blinking yellow and the scanner switches off.
Press and hold the button 10 sec.	on	The scanner switches off immediately. Hard shutdown.

2.2 Scanner Status

Scanner status













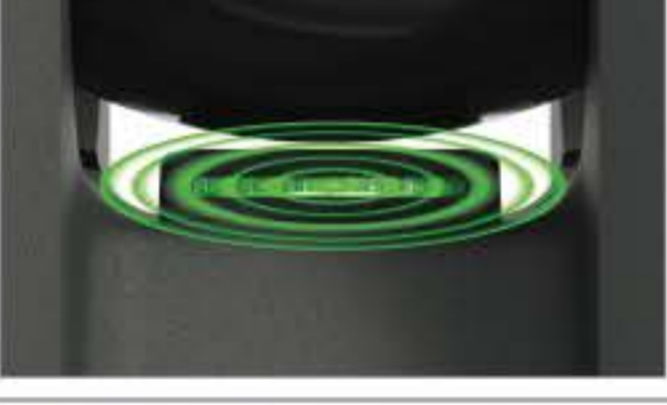

The power button and the LED indicator light up green, yellow or red to show the operation states of the scanner.

Component	Status
Power button	 lights up continuous.
	 is blinking.
	 is blinking.

Component	Status
LED indicator	 lights up continuous.
	 is blinking.
	 is blinking fast.

2.2 Scanner Status

Scanner status

Power button	LED indicator	Scanner status
		The scanner is off.
		The scanner is booting up.
		The scanner is ready and leveled within $\pm 10^\circ$ in upright or upside down orientation. High tilt accuracy of 18" is applied.
		The scanner is ready, but tilted more than $\pm 10^\circ$ in upright or upside down orientation. High tilt accuracy of 18" is not applied.
		The scanner is recording.
		The scanner is being moved and the visual inertial system is recording.
		The scanner is shutting down.
		An unrecoverable system error occurred. Follow the instructions in the display. If necessary, shut down the scanner and reboot again. If status does not change, contact the scanner support.

2.3 Screen

Screen overview

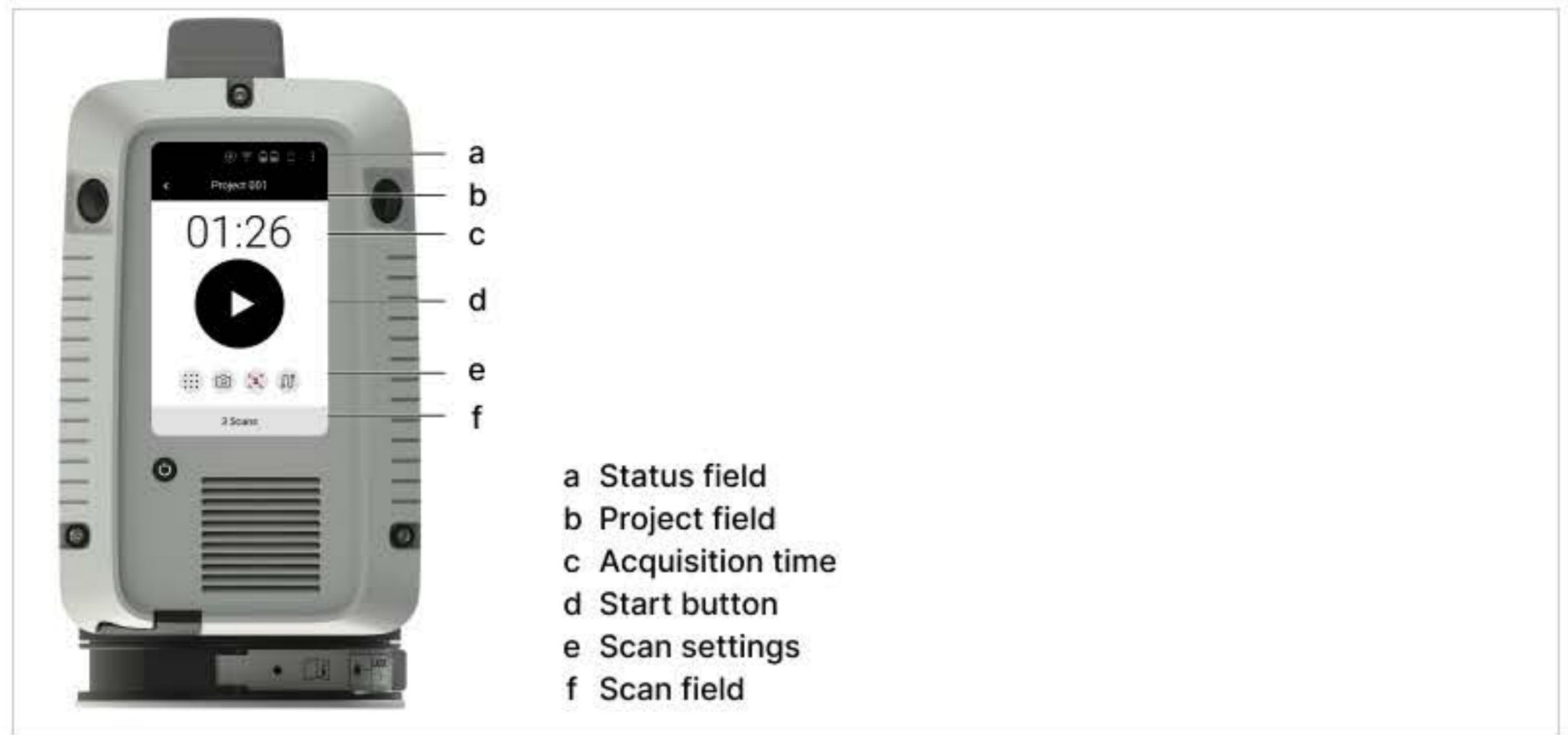

3 Operation

3.1 Scanner Setup

3.1.1 General Information

Use the tripod

The scanner should always be set up on its tripod. Using the tripod specified for the scanning system guarantees maximum stability during scanning operations.



Always set up the scanner on its tripod. Do not set up the scanner directly on the ground for scanning operations.



It is always recommended to shield the scanner from direct sunlight and avoid uneven temperatures around the scanner.

3.1.2 Heavy Duty Tripod Setup

Scanner setup step-by-step

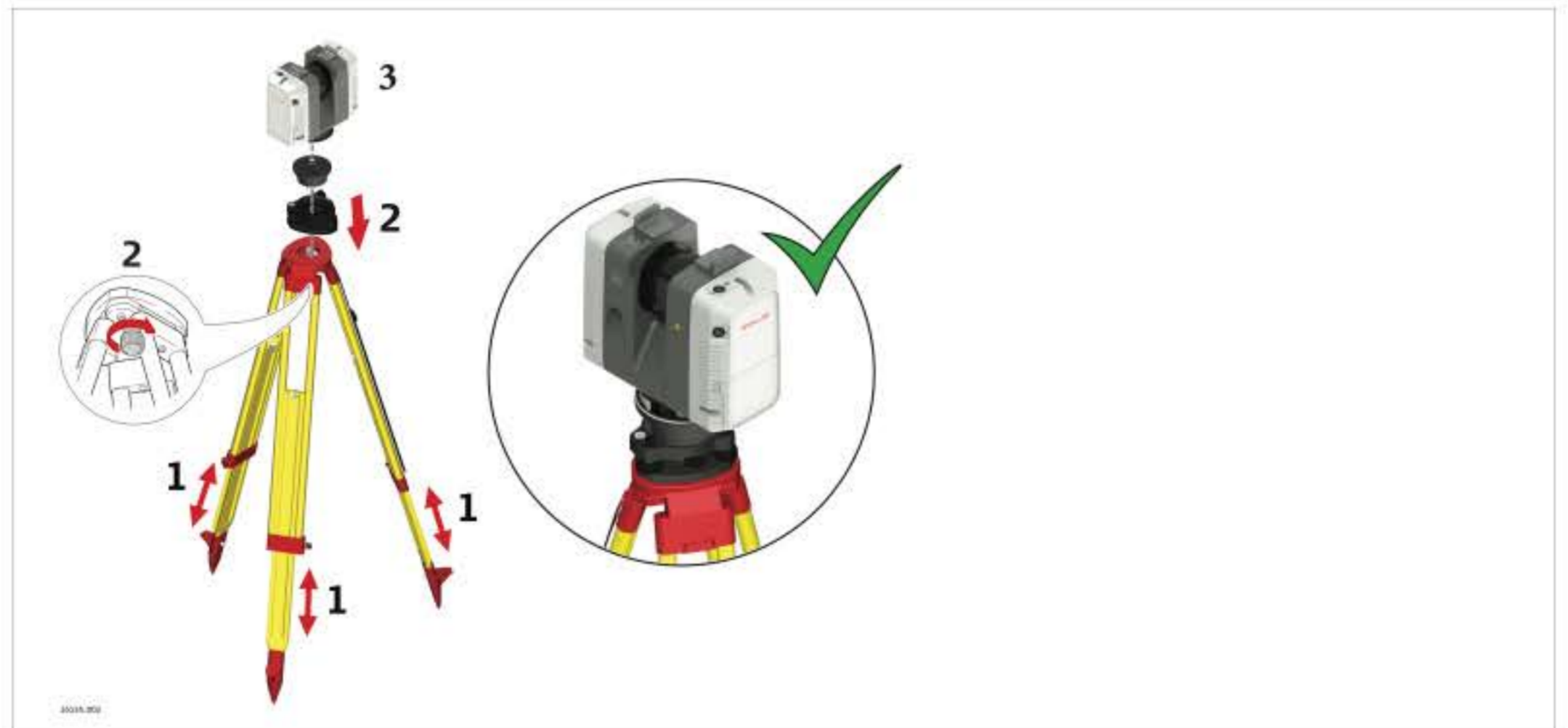

1. Extend the tripod legs to allow for a comfortable working posture. Ensure that the tripod plate is roughly horizontal.
2. Set the adapter on the tripod and secure it with the central fixing screw.
3. Place the scanner on the quick release mount and secure it.

3.2 Power Supply



For details regarding the charging station refer to Artec Ray II Multicharger User Manual.

3.2.1 Batteries

- First-time use/ charging batteries**
- The batteries must be charged before using them for the first time because they are delivered with an energy content as low as possible.
 - The permissible temperature range for charging is from 0 °C to +40 °C/ +32 °F to +104 °F. For optimal charging, we recommend charging the batteries at a low ambient temperature of +10 °C to +20 °C/+50 °F to +68 °F if possible.
 - It is normal for the battery to become warm during charging. Using the chargers recommended by Artec 3D, it is not possible to charge the battery once the temperature is too high.
 - For new batteries or batteries that have been stored for a long time (> three months), it is effectual to make a discharge/charge cycle.
 - For Li-Ion batteries, a single discharge/charge cycle is sufficient. We recommend carrying out the process when the battery capacity indicated on the charger or on an Artec 3D product deviates significantly from the actual battery capacity available.
-
- Operation/discharging**
- The batteries can be operated from -20 °C to +55 °C/-4 °F to +131 °F.
 - Low operating temperatures reduce the capacity that can be drawn.
 - High operating temperatures reduce the service life of the battery.

NOTICE

The batteries are hot-swappable. Data acquisition requires two batteries inserted into the battery compartment. The scanner does not shut down when only one battery is inserted.

3.2.2 Exchanging the Batteries

Insert and remove the exchangeable batteries

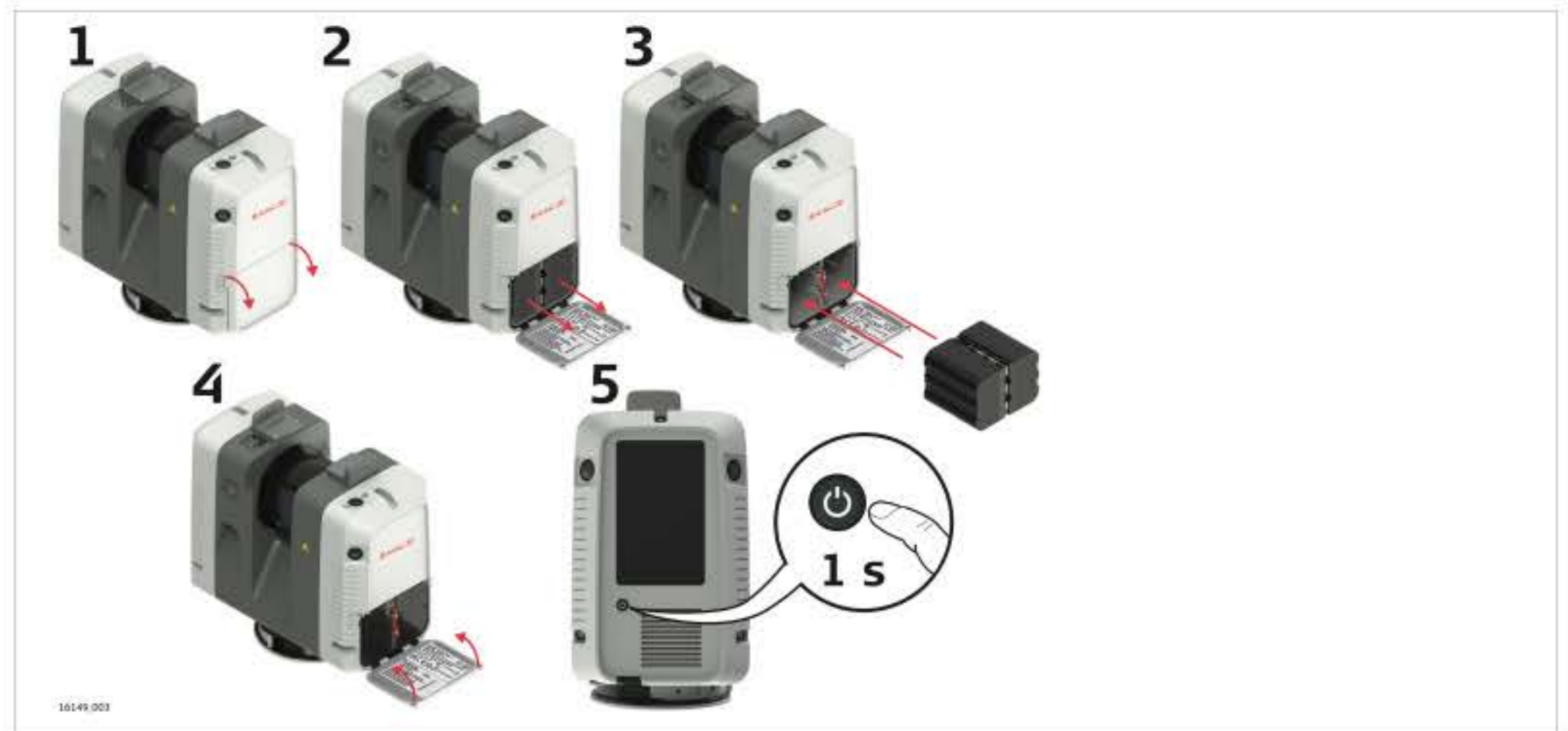

1. Open the battery compartment.
2. Remove the left battery from the battery compartment by pushing the upper red button to the right. Remove the right battery from the battery compartment by pushing the lower red button to the left.
3. Insert the new batteries into the battery compartment.
-  Ensure that the battery contacts are facing inwards.
4. Close the battery compartment.
5. Turn on the scanner to start the boot process.

3.3 Operation - Getting Started

Stand-alone operation step-by-step



1. Press the power button to turn on the scanner.
 2. The scanner is starting. The power button is blinking green and the LED indicator is blinking yellow.
 3. When the user interface is visible, the scanner is ready for operation. The power button and the LED indicator are now continuously green.
-  Do not touch or move the scanner while the system is recording.

3.3 Operation - Getting Started

Operation with hand-held device connection step-by-step

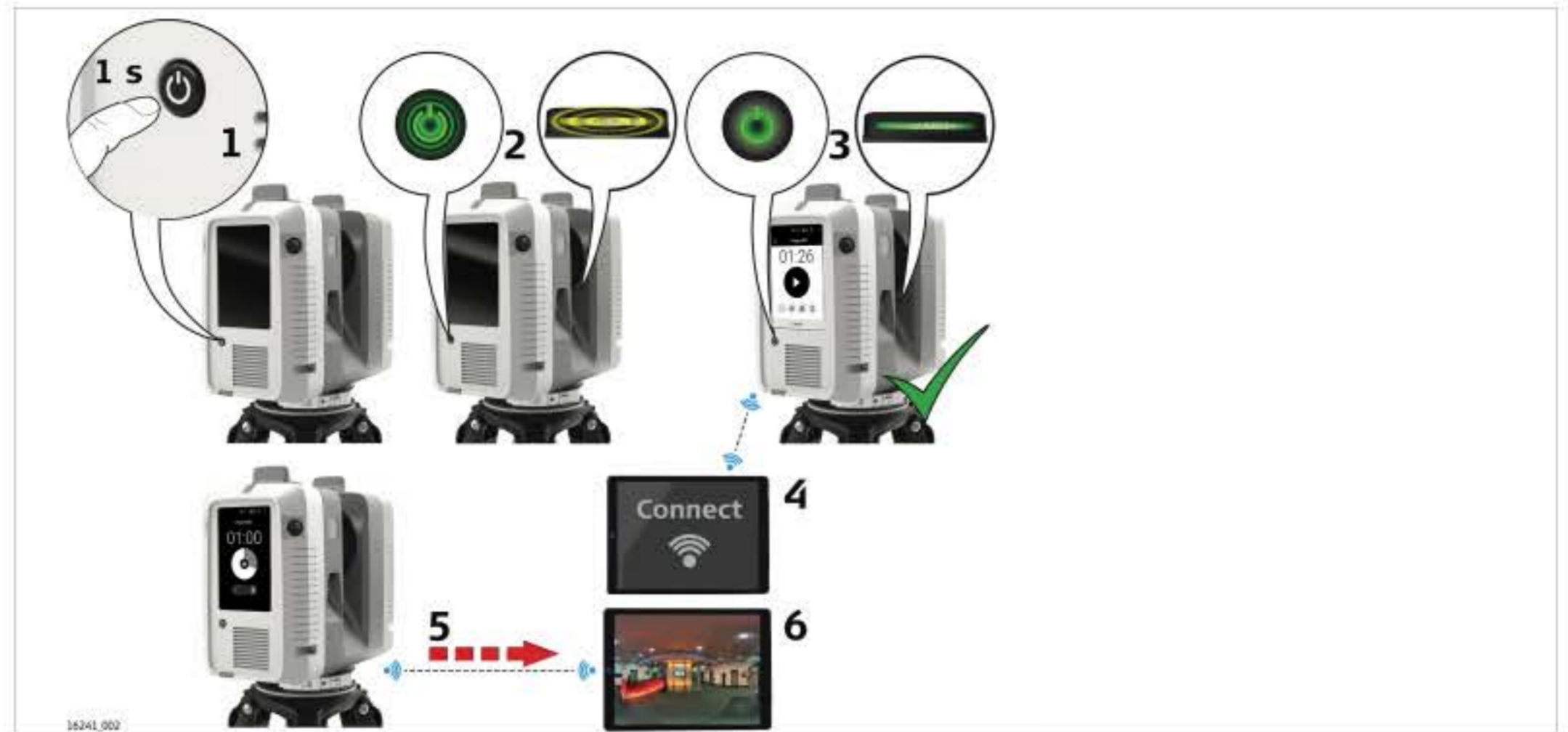

1. Press the power button to turn on the scanner.
2. The scanner is starting. The power button is blinking green and the LED indicator is blinking yellow.
3. When the user interface is visible, the scanners ready for operation. The power button and the LED indicator are now continuously green.
4. Connect the handheld device with the scanner.
5. Start the recording and simultaneous data transfer with the handheld device.
6. Start the processing of data on the handheld device.

Connecting to a hand-held device step-by-step

1. Start the scanner and wait until the user interface is visible.
2. On the handheld device select Settings and tap WLAN.
3. Select the network ArtecRay-298xxxx in the WLAN settings to be connected. The number 298xxxx/3005xxx is the serial number of the scanner.
4. Enter the password. The scanner specific password is printed on the type label in the battery compartment, for example "test1111".



5. Start the app and connect the scanner.



For further information, refer to the help menu in the app.

3.4 Imaging

Description

The scanner has two different types of image sensors:

- Three calibrated cameras for HDR, 360° spherical image acquisition.
- Five calibrated cameras for the visual inertial system VIS.

Imaging



3.5 Scanning

3.5.1 Ambient Conditions

Unfavourable surfaces for scanning

- Highly reflective (polished metal, gloss paint)
- Highly absorbent (black)
- Translucent (clear glass)



Color, powder or tape these surfaces before scanning if necessary.

Unfavourable weather conditions for scanning

- Rain, snow or fog may adversely affect measurement quality. Always use care when scanning in these conditions.
- Surfaces that are directly illuminated by the sun cause an increased range noise and therefore a larger measurement uncertainty.
- If some objects are scanned against the sunlight or a bright spotlight, the optical receiver of the scanner can be dazzled so heavily that in this area no measured data is recorded.

Temperature changes during scanning

If the scanner is brought from a cold environment, for example from storage, into a warm and humid environment, the mirror or in extreme cases even the interior optics can condense. This may cause measurement errors.



Precaution: Avoid rapid temperature changes and give the scanner time to acclimatize.

Dirt on the rotating mirror-protection glass







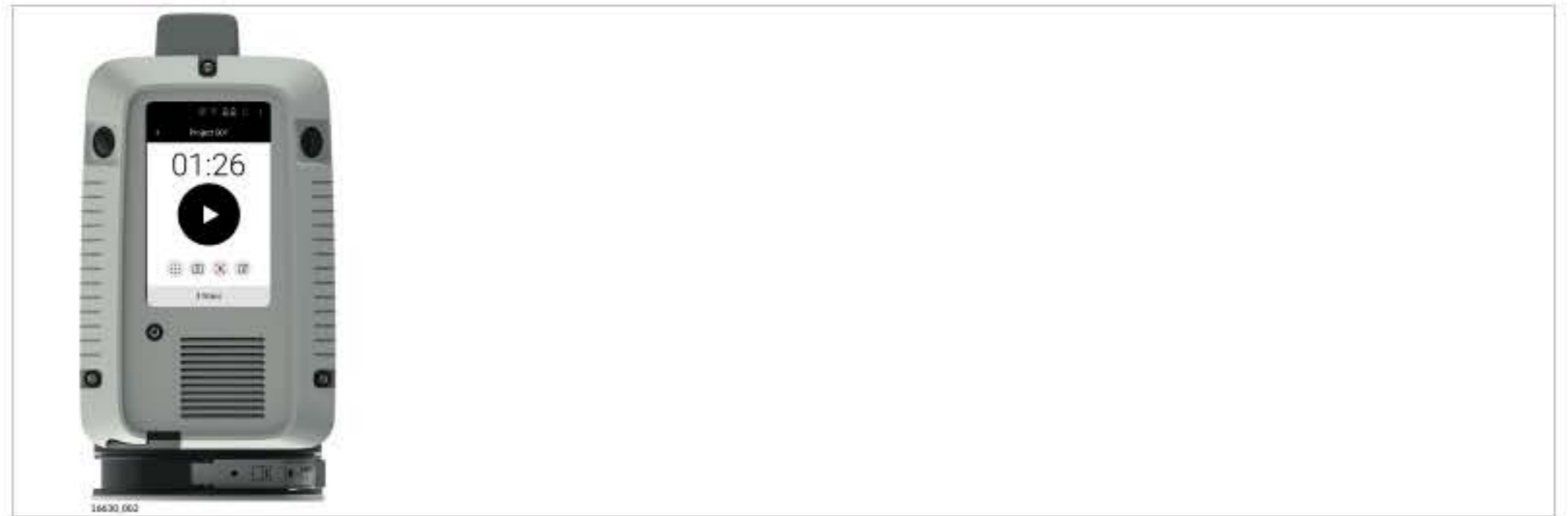

Due to the encapsulated mirror design, the mirror is protected against direct contact. However, dirt on the rotating mirror protection glass such as a layer of dust, condensation or fingerprints may cause considerable measuring errors.

3.5.2 Onboard Controls

About the Start screen











The Start screen is displayed after the system boot process. Once it is visible the scanner is ready for scanning.



Element	Description
Status field	 <p>High Tilt Accuracy</p> <p>High Tilt Accuracy mode enabled. Scanner is leveled within $\pm 10^\circ$ in upright or upside down orientation. High tilt accuracy of 18" is applied.</p>
	 <p>High Tilt Accuracy mode enabled. Scanner is tilted more than $\pm 10^\circ$ in upright or upside down orientation. High tilt accuracy of 18" is not applied.</p>
	 <p>WLAN enabled</p>
	 <p>Status of exchangeable battery</p> <p>100% - 75% of capacity left</p>
	 <p>75% - 25% of capacity left</p>
	 <p>25% - 12% of capacity left</p>
	 <p>Less than 12% of capacity left</p>
	 <p>Battery not inserted</p>











3.5.2 Onboard Controls

About the Start screen

Element	Description
Status field	 <p>When facing the battery compartment:</p> <ul style="list-style-type: none">• Left battery icon indicates the status of the battery on the left side of the battery compartment.• Right battery icon indicates the status of the battery on the right side of the battery compartment.
	 <p>0% - 25% of storage used</p>
	 <p>25% - 75% of storage used</p>
	 <p>More than 75% of storage used</p>
	 <p>USB storage device not attached</p>
	 <p>Do not remove the USB storage device.</p>
	Project field
 <p>Name of the current project</p>	
Status of data security	 <p>Project not signed</p>
	 <p>Project signed</p>
	 <p>Project signed, but modified</p>

3.5.2 Onboard Controls

About the Start screen

Element		Description
Time		Display of the acquisition time depending on the scan settings.
Start		Click the Start button to start the scan and image acquisition as defined in the scan settings.
Scan settings		Low scan resolution: 12 mm@10 m, maximum range 130 m
		Medium scan resolution: 6 mm@10 m, maximum range 130 m
		High scan resolution: 3 mm@10 m, maximum range 65 m
		HDR image acquisition enabled
		HDR image acquisition disabled
		Double Scan enabled
		Double Scan disabled
		Visual inertial system VIS enabled
	Visual inertial system VIS disabled	
Start	7 setups	Number of scans in the current project. Click the Scan field to open the scans list with a thumbnail for each scan.

3.5.3 Settings

About the Settings screen



Settings options in Settings screen:

- Scan settings
- Scanner settings
- Language
- Date and Time
- Data security







Further options:

- Upload language files
- Upgrade firmware
- Transfer log files
- Perform a Check & Adjust procedure
- Sign projects

View:









- System information
- Legal information
- Regulatory information
- US patents

To close the Settings screen tap the backwards arrow

Element	Description
Scan settings	
 Resolution Low	Tap the arrow to select a scan resolution (low, medium or high) from the dropdown menu.
 Image	Tap the checkbox to enable HDR image acquisition.
Adaptive Resolution	Tap the checkbox to enable adaptive image resolution. Image resolution gets automatically adapted to suit the selected scan resolution.
	By default, the setting is disabled. To get images with highest resolution for all kinds of scan resolutions keep the setting disabled.
 Double Scan	Tap the checkbox to enable Double Scan.
 VIS	Tap the checkbox to enable the visual inertial system VIS.
 High Tilt Accuracy	Tap the checkbox to enable High Tilt Accuracy mode. In order to achieve the specified high tilt accuracy, the approximate GPS position of the scanner must be known.

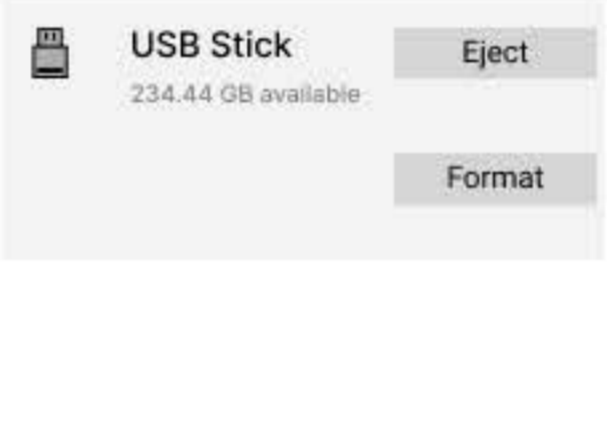



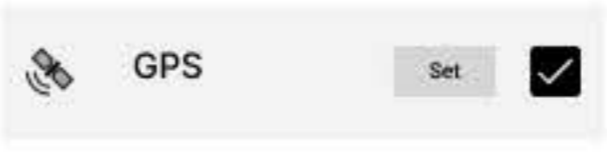





3.5.3 Settings

About the Settings screen

Element		Description
		High Tilt Accuracy is applied only when the scanner is positioned inside the working range of the High Tilt Accuracy mode. This is indicated by the icon in the status field of the display and by the LED indicator. Refer to 2.2 Scanner Status and 3.5.2 Onboard Controls .
		It is recommended to leave the GPS setting enabled so that the scanner's position is automatically updated.
		Make sure that the GPS position is updated after travelling with the scanner a long distance (> 100 km) before starting a project in a new location.
		The scanner's GPS position can be updated manually by tapping the Update button. Refer to Scanner settings .
Scanner settings		Tap the checkbox to enable WLAN.
		<p>The storage space available on the USB stick is displayed.</p> <ul style="list-style-type: none"> • Tap Eject to remove the USB stick. • Tap Format to perform a quick format of the USB stick.
		In order to avoid loss of data, only remove the USB stick when the Eject function has been completed.
		Formatting is irreversible. Make sure to back up the data from USB stick before formatting to avoid loss of data. When quick Format is performed the content of the USB stick is deleted and default directories "ArtecRayStore" and "Languages" are automatically created.
		Tap the checkbox to enable GPS. The GPS position of the setup is stored if available.
		Tap Set to set the current GPS position of the scanner. The Set button is only displayed if the GPS position has not yet been stored on the scanner.

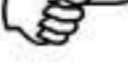









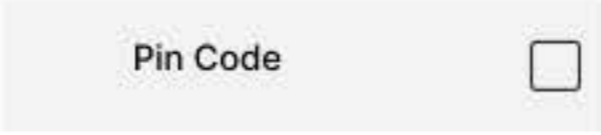

3.5.3 Settings

About the Settings screen

Element	Description
 GPS <input type="button" value="Update"/> <input checked="" type="checkbox"/>	Tap Update to manually update the current GPS position of the scanner.
	If a GPS position is unavailable, move the scanner to an area with an open view to the sky.
 Compass <input type="checkbox"/>	Tap the checkbox to store and use the compass reading with the setup.
 Altimeter <input type="checkbox"/>	Tap the checkbox to determine and use relative height differences.
 Altimeter <input type="button" value="Set"/> <input checked="" type="checkbox"/>	Tap Set to set the atmospheric pressure at your reference elevation.
 Altimeter <input type="button" value="Update"/> <input checked="" type="checkbox"/>	Tap Update to update the atmospheric pressure at your reference elevation.
<input type="checkbox"/> LED Indicator	Tap the checkbox to enable the LED indicator.
<input type="checkbox"/> Monitor Tilt Change	Tap the checkbox to enable monitoring of tilt change occurred during data acquisition.
	To detect a tilt change of the scanner, tilt values measured before and after data acquisition are compared.
	A notification of a change in tilt is displayed when the data acquisition is completed.
	By default the setting is enabled after each startup of the device. Disable Monitor Tilt Change only when using the scanner on moving platforms such as ships, offshore platforms.
	When the setting is disabled, measured tilt values are not stored.
	To use the High Accuracy Tilt mode, the Monitor Tilt Change setting must be enabled.
<input type="checkbox"/> Show Preview	Tap the checkbox to enable a scan preview. The preview will be shown when the scan is completed.
 Sound <input type="checkbox"/>	Tap the checkbox to enable sound notifications.



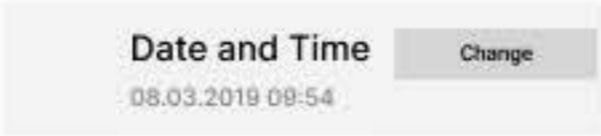

3.5.3 Settings

About the Settings screen



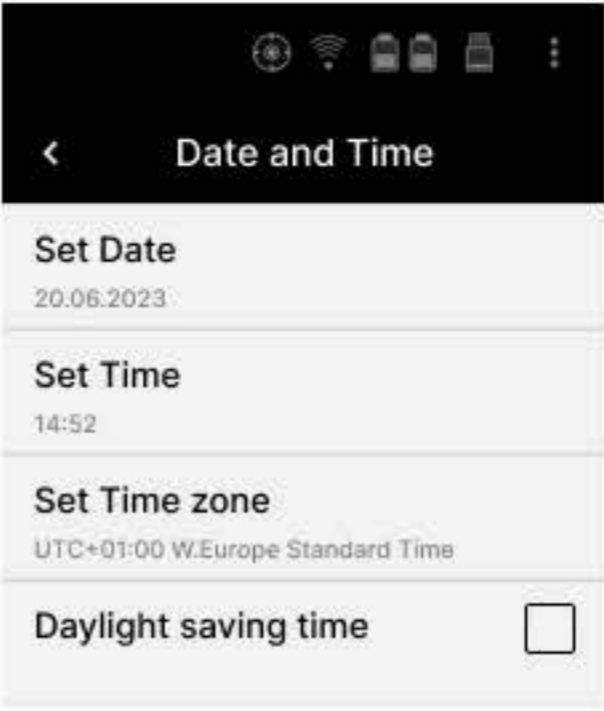
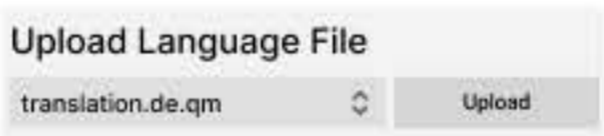



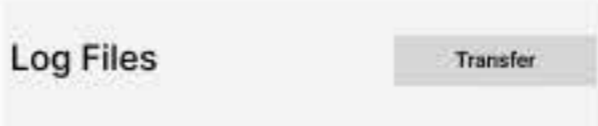

Element		Description
PIN code protection		Tap the checkbox to configure the Pin Code protection. The Pin Code screen opens up.
		Tap the checkbox to activate protection by a PIN code.
		Tap the input field to enter a 6-digit Pin Code.
		Tap the dropdown list to select an inactivity Timeout after which the PIN code must be entered.
		Tap the Back arrow at the top of the screen to confirm your configuration and return to the Settings screen.
		Tap the Close icon at the top of the screen to cancel your configuration and return to the Settings screen.
		When Active, the PIN code must be entered each time the scanner is started up or when the timeout expires.
		If an incorrect PIN code has consecutively been entered five times, the scanner is locked. An unlocking key must be loaded to unlock the scanner. In order to get the unlocking key, contact the Artec 3D Support Team .
Data security		Tap the checkbox to activate Data Security.
		Data Security must be enabled before a new job is created. The job status is indicated by the status of the lock icon right to the job name. Refer to 3.5.2 Onboard Controls for the icon status.
		For more details about the Data Security workflow refer to the separate Data Security User Manual.
Language settings		Tap the arrow to select one of the available languages from the list. To upload more languages use the Upload Language File tool (see below).
Date/Time settings		Tap Change to open the Date and Time screen, in which the system time can be configured.

3.5.3 Settings

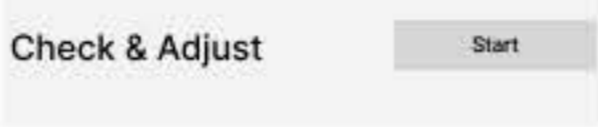
About the Settings screen

Element	Description
	<p>Tap Set Date to enter a local date.</p> <p>Tap Set Time to enter a local time.</p> <p>Tap Set Time Zone to select a time zone.</p> <p>Tap the checkbox in order to adjust the time to daylight saving time.</p>
	<ol style="list-style-type: none">1. Copy the language file (*.qm) to the Languages directory on the USB stick.2. Attach the USB stick to the scanner.3. Tap the double arrow and select the language file from the dropdown list.4. Tap Upload.
	<p>A language can be activated directly after upload. A confirmation message will be displayed. Tap YES to activate the language.</p> <p>Tap NO to keep the current language.</p>
Firmware upgrade 	<p>A firmware upgrade can take up to 30 minutes. Make sure that you have got sufficient battery power or provide AC power. Do not interrupt power supply during the upgrade process.</p>
	<ol style="list-style-type: none">1. Copy the firmware file (*.fw) to the root directory on the USB stick.2. Attach the USB stick to the scanner.3. Tap the double arrow and select the firmware file from the dropdown list.4. Tap Upgrade.5. Accept the Artec 3D Software License Agreement to start the upgrade process. <p>When the upgrade is complete the scanner is restarted.</p>

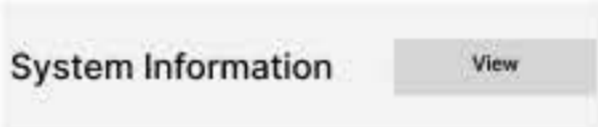
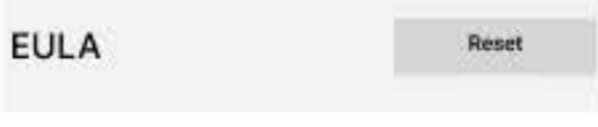
3.5.3 Settings

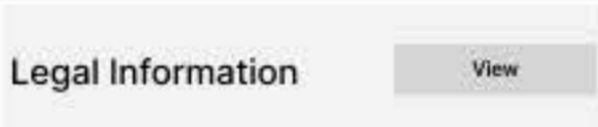
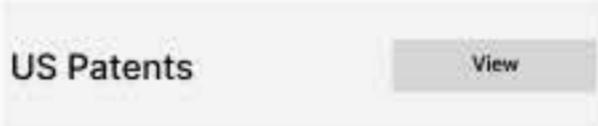
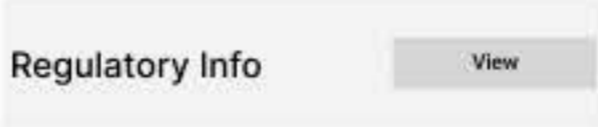
Element		Description
Transfer of log files	 	<p>1. Attach the USB stick to the scanner.</p> <p>2. Tap Transfer in order to export logfiles (*.logs) to the Logs directory on the USB stick.</p> <p>A transfer of logfiles can take up to 5 minutes. When the transfer is complete a message is displayed.</p>
Check & Adjust	   	<p>Tap Start to start the Check & Adjust procedure.</p> <p>Before performing the Check & Adjust, read the separate Artec Ray II Check & Adjust User Manual.</p> <p>Refer to section 4.2 Check & Adjust for more information about the Check & Adjust.</p> <p>Do not remove the USB stick during Check & Adjust procedure.</p>
System information		<p>Tap View to get displayed information like:</p> <ul style="list-style-type: none"> • Scanner Type • Serial Number • Firmware Version • WLAN Password • Internal Temperature
Resetting EULA	 	<p>Tap Reset to reset the EULA (end-user license agreement).</p> <p>With the next startup of the scanner, the EULA is displayed and must be accepted before the scanner can be used.</p>
Viewing information	  	<p>Tap View to display legal information.</p> <p>Tap View to get displayed US patents.</p> <p>Tap View to get displayed regulatory information.</p>

3.5.4 Troubleshooting

Element	Possible Cause(s)	Suggested Remedies
Missing points in scan.	Dust, debris or fingerprints on the rotating mirror-protection glass.	Use a glass cleaning tissue to clean the specific areas.

3.5.4 Troubleshooting

Advanced troubleshooting

Problem	Possible Cause	Suggested Remedies
When switching on the scanner or starting a scan, the system switches off automatically.	Capacity of battery is too low.	Recharge or change battery.
When switching on the scanner or starting a scan, the system switches off automatically even though it was totally recharged.	Battery charger is defective.	Check the function of the battery charger. Please note the charging status displayed on the battery charger.
	Exchangeable battery is no longer charging.	At the end of its life time the exchangeable battery has lost most of its capacity. The battery needs to be replaced.

Troubleshooting - support contacts

If you experience problems with your scanner, e-mail the scanner's log files to [Artec 3D Support Team](#).



Log files can be transferred to the USB stick using the Transfer command in the Settings screen.

3.5.5 Field of View (FoV)

Scanning laser - field of view

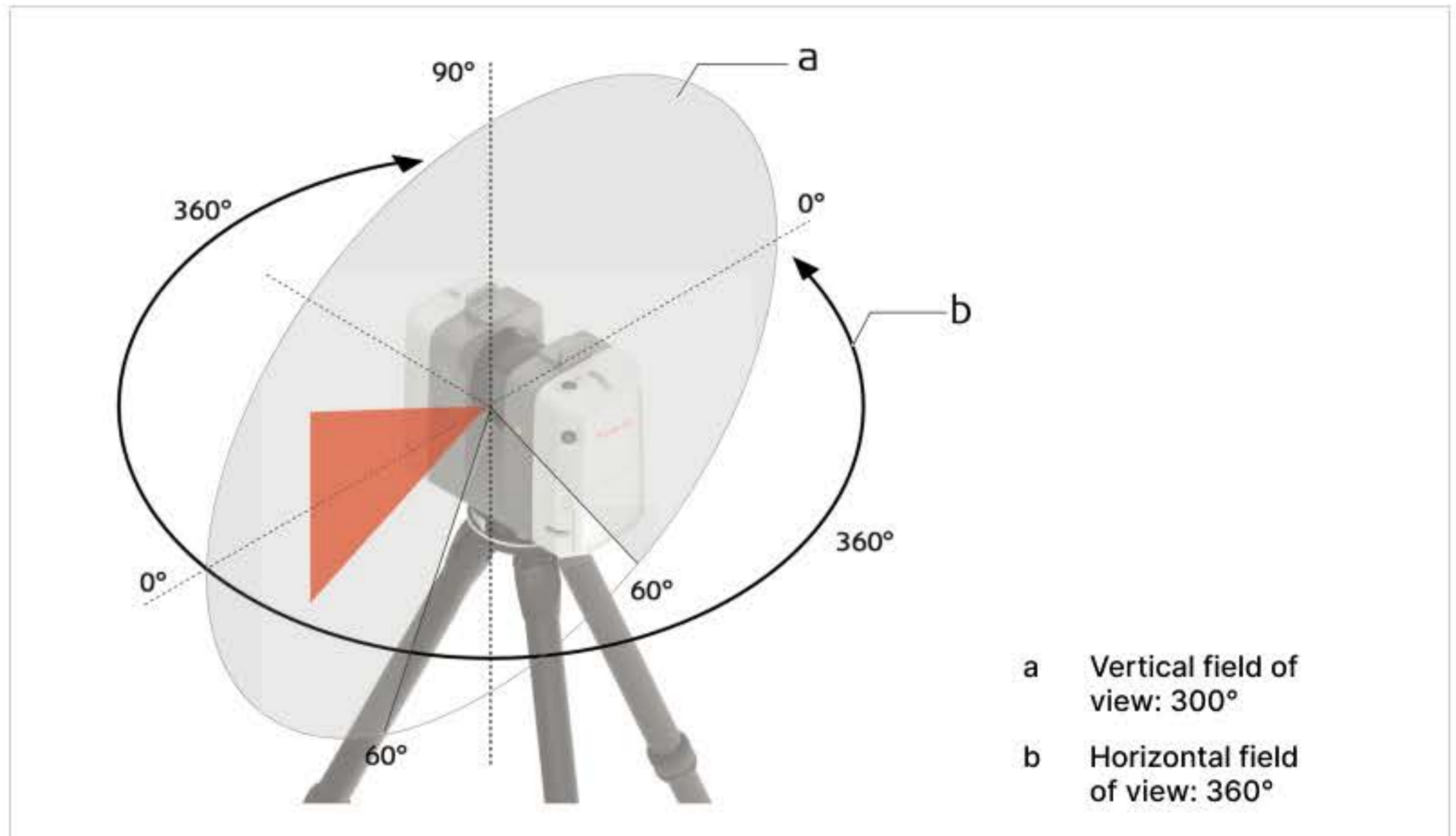

3.6 Data Transfer

Description

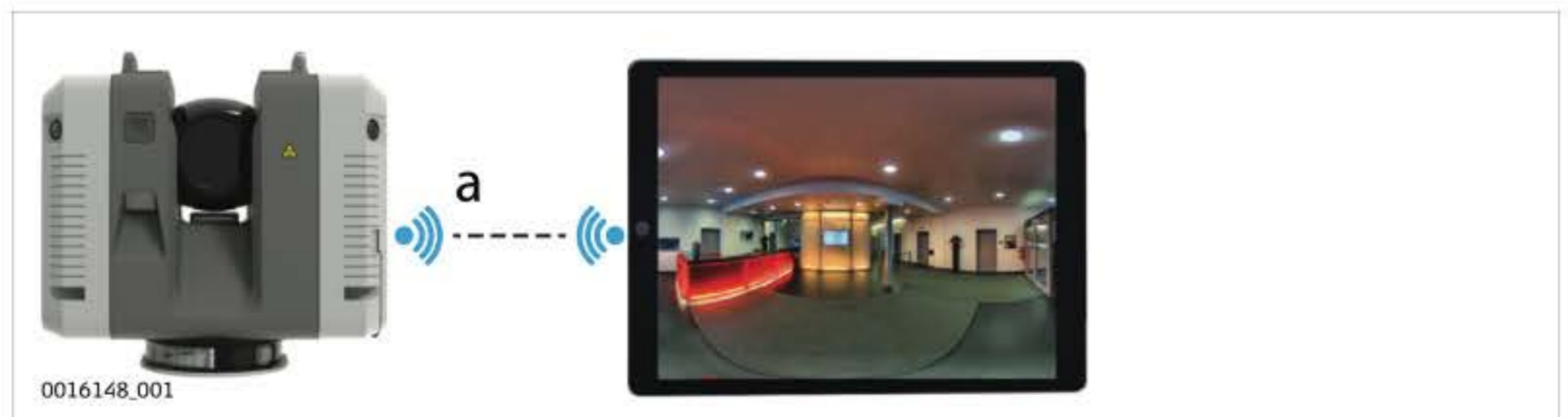

- Preview data transfer from scanner to handheld device. Refer to [3.3 Operation - Getting Started](#).

3.7 Working with the USB Data Storage Device



- Keep the USB data storage device dry.
- Use it only within the specified temperature range.
- Do not bend the USB data storage device.
- Protect the USB data storage device from direct impacts.

Insert and remove the USB data storage device.



Only remove the USB data storage device after it has been checked out from the system using the Eject functionality in the Settings menu.



Failure to follow these instructions could result in data loss and/or permanent damage to the USB data storage device.



Element	Description
1.	Open the USB compartment at the bottom of the scanner.
2.	To insert the USB data storage device, hold the USB data storage device with the Artec logo facing to the right. Slide it into the USB slot until it clicks into position.
	Do not force the USB data storage device into the slot.
3.	To remove the USB data storage device, slide the USB data storage device out of the USB slot.
4.	Close the USB compartment.

3.8 Description of the System

3.8.1 Packing / Unpacking the Scanner

Packing and unpacking

When in its transport container, the scanner can sit in either a face-up or face-down position.



To take the scanner out of its container, grasp the scanner at the left and right side covers, and lift.



Use caution due to the weight of the scanner (6 kg).

3.8.2 Container Contents

Container contents



3.8.3 Scanner Components

Scanner components



3.8.4 System Components

System components



3.8.5 System Concept

3.8.5.1 Power Concept

General

Use the batteries, chargers and accessories recommended by Artec 3D to ensure the correct operation of the scanner.

Power options

Model	Power supply
All scanner types	Internally by battery, or externally by Power supply (for indoor use only).

3.8.5.2 Data Storage Concept

Description

Data is stored on an exchangeable USB data storage device.

Data storage device

The scanner comes with two USB sticks (exFAT formatted) which fit into the USB slot of the scanner.



Only use the Artec USB stick. Other devices are not compatible and may damage the scanner.



Unplugging connecting cables or removing the USB stick during the measurement can cause loss of data. Only remove the USB stick or unplug connecting cables when the Eject USB stick function has been executed.

Data transfer

The USB stick is used to transfer data from the scanner to external computers. All data recorded by the scanner and all meta data created by the field app on the remote tablet is stored on the USB stick.

Type	Description
Data	Scans, images, orientation
Meta data	Registration, tags, images

4 Care and Transport

4.1 Transport

Transport in the field	<p>When transporting the equipment in the field, always make sure that you:</p> <ul style="list-style-type: none">• either carry the product in its original container• or in the backpack• or carry the tripod with its legs splayed across your shoulder, keeping the attached product upright.
Transport in a road vehicle	<p>Never carry the product loose in a road vehicle, as it can be affected by shock and vibration. Always carry the product in its container and secure it.</p> <p>For products for which no container is available use the original packaging or its equivalent.</p>
Shipping	<p>When transporting the product by rail, air or sea, always use the complete original Artec 3D packaging, container and cardboard box, or its equivalent, to protect against shock and vibration.</p>
Shipping, transport of batteries	<p>When transporting or shipping batteries, the person responsible for the product must ensure that the applicable national and international rules and regulations are observed. Before transportation or shipping, contact your local passenger or freight transport company.</p>

4.2 Check & Adjust



For units that are exposed to high mechanical forces, for example through frequent transport or rough handling, perform the Check & Adjust periodically. Perform the Check & Adjust also for units, which were stored for a long period.

The Check & Adjust procedure is a smart and user-friendly solution. It does not require a specific measurement field having a prescribed configuration of targets. This feature makes Check & Adjust a quick and fully automated procedure that allows the user to:

- check the current angular accuracy of the scanner
- adjust the angular parameters to improve the angular accuracy of the scanner.

Refer to the separate Artec Ray II Check & Adjust User Manual:

- for more information about the Check & Adjust
- how to select a suitable location to perform a Check & Adjust.



Before performing the Check & Adjust, read the separate Artec Ray II Check & Adjust User Manual.

4.3 Storage

Artec Ray II	<p>Respect the temperature limits when storing the equipment, particularly in summer if the equipment is inside a vehicle. Refer to 5.5 Environmental Specifications for information about temperature limits.</p>
---------------------	--

4.3 Storage

Li-Ion battery

- Refer to [5.5 Environmental Specifications](#) for information about storage temperature range.
 - Remove batteries from the product and the charger before storing.
 - After storage recharge batteries before using.
 - Protect batteries from damp and wetness. Wet or damp batteries must be dried before storing or use.
 - A storage temperature range of 0 °C to +30 °C/+32 °F to +86 °F in a dry environment is recommended to minimize self-discharging of the battery.
 - At the recommended storage temperature range, batteries containing a 40% to 50% charge can be stored for up to one year. After this storage period the batteries must be recharged.
-

Charger and Power supply

- Keep chargers and power supply away from excessive dirt, dust and contaminants.
 - After unpacking the product, visually inspect the charger for possible damages.
 - Unplug the product from the outlet before attempting any maintenance or cleaning.
-

4.4 Cleaning and Drying

Housing parts of product and accessories

- Never touch the glass surfaces or the rotating mirror-protection glass with your fingers.
 - Only use a clean, soft, lint-free cloth for cleaning. If necessary, moisten the cloth with water or pure alcohol. Do not use other liquids; other liquids may attack the polymer components.
-

Damp products

Dry the product, the backpack, the transport container, the foam inserts and the accessories at a temperature not higher than 40 °C /104 °F and clean them. Open the battery cover and dry the battery compartment. Do not repack until everything is completely dry. Always close the container or backpack when using in the field.

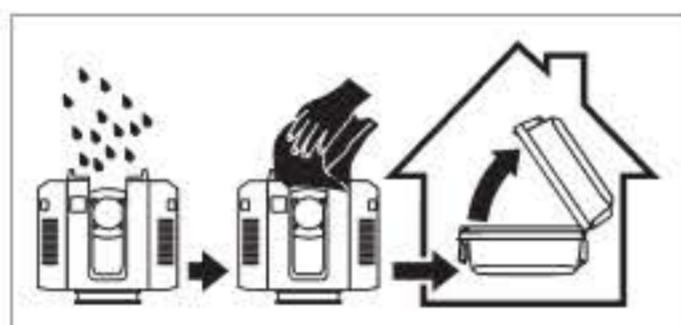

Charger and AC/DC power supply

Use only a clean, soft, lint-free cloth for cleaning.

Cables and plugs

Keep plugs clean and dry. Blow away any dirt lodged in the plugs of the connecting cables.

4.5 Glass Cleaning Procedure

General cleaning information

The scanning window must be kept clean. The instructions must be followed as described in this chapter to clean the scanner window.

CAUTION

Before any cleaning procedure, ensure that the scanner is switched off and the battery has been removed.

4.5 Glass Cleaning Procedure

Dust and debris on optical surfaces



Using only a compressed gas duster to remove dust and debris from surface of scanner window.

Never rub off dust or debris as this will scratch the glass and so possibly cause permanent damage to the special optical coatings.

Cleaning of optical surfaces



Soiling of the glass pane can cause extreme measurement errors and therefore useless data!

All soiling that is visible on the glass pane has to be removed, except for single small dust particles that adhere inevitably.

For the glass cleaning procedure we recommend to use soft cleaning tissue for the optics:

- Switch off scanner and remove the battery.
- Washing hands is necessary in order to avoid grease on the cleaning tissue.
- Better, use gloves to avoid finger oil on the glass.
- Then use the cleaning tissue.
- If any smears from cleaning are visible against back light, repeat the procedure.
- Do not use air from the pneumatic power system as this is always slightly oily!

4.6 Maintenance



An inspection of the product must be done in an Artec 3D company authorized service workshop. Artec 3D recommends an inspection of the product every 12 months.

5 Technical Data

5.1 General Technical Data of the Product



For details regarding the charging station refer to Artec Ray II Multicharger User Manual.

Storage and communication

Function	Component
Internal storage	Exchangeable 256 GB USB 3.0 storage device 235 GB effective, exFAT formatted
Communication	Integrated 802.11 a/b/g/n WLAN

Internal HDR cameras

The scanner has three integrated HDR digital cameras.

Camera data	Value
Type	Colour sensor, fixed focal length
Single image	4000 × 3000 pixels, 62° × 48° (V × Hz) 2000 × 1500 pixels for medium scan resolution with Adaptive Resolution enabled. Refer to 3.5.3 About the Settings screen . 1000 × 750 pixels for low scan resolution with Adaptive Resolution enabled. Refer to 3.5.3 About the Settings screen .
Colour depth	8-bits per RGB channel
Full dome	36 images, automatically spatially rectified, 432 Mpx raw data, 108 and 27 Mpx raw data for medium and low scan resolution with Adaptive Resolution enabled. Refer to 3.5.3 About the Settings screen . 360° × 300° 200 Mpx on point cloud with 3 mm resolution
White balancing	Automatic
HDR	Automatic, 5 brackets
Minimum range	0.5 m

Additional internal sensors

The Artec Ray II is a multi-sensor system equipped with various integrated sensors to allow for automated or semi-automated online registration in the field.

Sensor	Description
Visual inertial system VIS	Video enhanced inertial measuring system to track movement of the scanner position relative to the previous setup in real-time.
Tilt	IMU-based. High Tilt Accuracy: 18" in working range ± 10° for upright and upside down orientation of the scanner with enabled High Tilt Accuracy setting. Any Tilt Accuracy: 3' for any tilt.
Altimeter	Electronic barometer to detect the difference in elevation relative to a reference elevation.
Compass	Electronic compass to deliver the orientation of the scanner.
GNSS	Onboard GNSS receiver to calculate the position of the scanner.

5.2 System Performance

System Performance and Accuracy

All accuracy specifications are on a level of confidence of 68% according to the Guide of the Expression of Uncertainty in Measurement (JCGM100:2008).

Angle accuracy of single measurement

Accuracy (horizontal/vertical)

18"/18"

3D point accuracy of single measurement

Albedo	Distance [m]				
	5	10	20	40	60
White 89%	1.4 mm	1.9 mm	2.9 mm	5.3 mm	7.8 mm
Grey 21%	1.5 mm	2.0 mm	3.2 mm	5.7 mm	8.2 mm
Black 8%	1.6 mm	2.2 mm	3.4 mm	6.1 mm	8.8 mm

5.3 Laser System Performance

Laser scanning system data

The scanning system is a high speed time-of-flight unit, enhanced by Waveform Digitising (WFD) technology with a maximum scan rate of:

- Artec Ray II: 2.000.000 points/second

Scanning laser	Value
Classification	Laser Class 1 (in accordance with IEC 60825-1 (2014-05))
Wavelength	1550 nm (invisible)

Range:

Scanning data	Value
Beam divergence	0.5 mrad (1/e2, full angle)
Beam diameter at front window	6 mm (1/e2)
Minimum range	0.3 m
Maximum range	130 m @ 89% albedo
Range accuracy	1.0 mm +10 ppm from 0.5 m to 130 m

Range noise of single measurement:

Albedo	Distance [m]				
	5	10	20	40	60
White 89%	0.3 mm	0.4 mm	0.5 mm	0.6 mm	1.0 mm
Grey 21%	0.4 mm	0.5 mm	0.6 mm	0.8 mm	2.0 mm
Black 8%	0.5 mm	0.6 mm	0.7 mm	2.5 mm	5.0 mm

5.3 Laser System Performance

Field-of-View (per scan):

Field-of-View	Value
Selection	Always full dome
Horizontal	360°
Vertical	300°
Scanning optics	Vertically rotating mirror on horizontally rotating base

Maximum range for 3 settings:

Point density mode	Resolution [mm @ 10 m]	Maximum range [m]
Low	12	130
Medium	6	130
High density	3	65

Scan duration for 3 settings:

Point density mode	Resolution [mm @ 10 m]	Estimated scan duration [MM:SS] for a full dome scan Artec Ray II
Low	12	00:25
Medium	6	00:50
High density	3	01:40

Image capturing time:

Camera type	Estimated image duration [MM:SS]
HDR	01:00

Estimated scan size for different settings:

Point density mode	Approx. scan size [Points Hz × V]	Scan without colour [MB]	Double Scan without colour [MB]
Low	2083 × 5084	40	76
Medium	4166 × 10168	151	296
High density	8333 × 20334	586	1145

Point density mode	Approx. scan size [Points Hz × V]	Scan with colour [MB]		Double Scan with colour [MB]	
		Full resolution	Adaptive resolution	Full resolution	Adaptive resolution
Low	2083 × 5084	296	92	333	129
Medium	4166 × 10168	408	373	551	516
High density	8333 × 20334	849	849	1413	1413

5.4 Electrical Data

Artec Ray II power supply and consumption

Power supply:

Exchangeable battery

Two exchangeable batteries needed for operation.

Power consumption:

Scanner

30 W typical; 75 W max.

Exchangeable battery

Supply	Value
--------	-------

Type	Li-Ion
------	--------

Voltage	10.8 V
---------	--------

Capacity	6.7 Ah
----------	--------

Battery operating and charging times

Exchangeable battery	Value
----------------------	-------

Operating time	Up to 60 setups per battery set, typical continuous use: <ul style="list-style-type: none">• at room temperature• with medium resolution• with Imaging/VIS enabled.
----------------	---

Charging time	Typical charging time with Multicharger is 4-8 hours at room temperature. <ul style="list-style-type: none">• 1-2 batteries: up to 4 h• 3-4 batteries: up to 8 h
---------------	---

Power supply

Mode	Value
------	-------

Input	100-240 V AC, 50-60 Hz, 2.0 A
-------	-------------------------------

Output	24 V DC, 6.25 A, 150 W
--------	------------------------

5.4.1 Pin Assignment of Lemo Ports

Ethernet port

Lemo1, 8 pin female

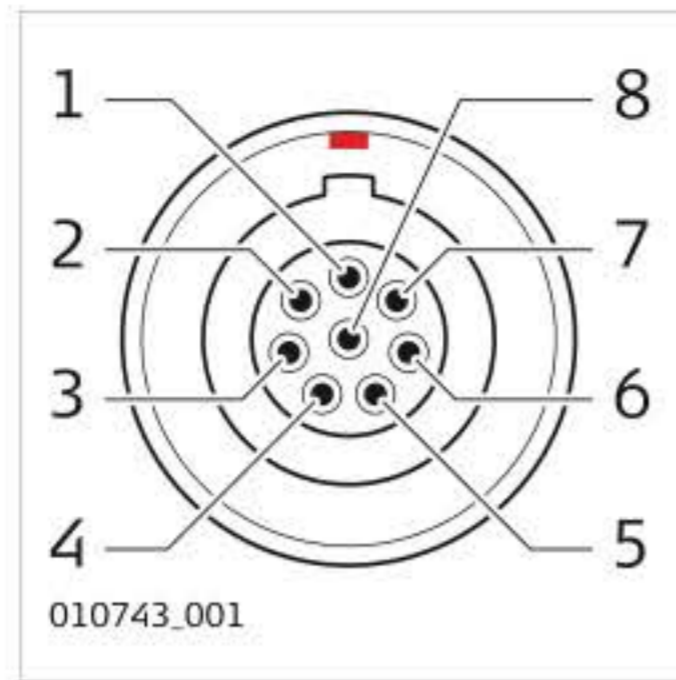

Pin	Name
1	D1+
2	D1-
3	D2+
4	D2-
5	D3+
6	D3-
7	D4+
8	D4-

Power supply port

Lemo1, 5 pin female

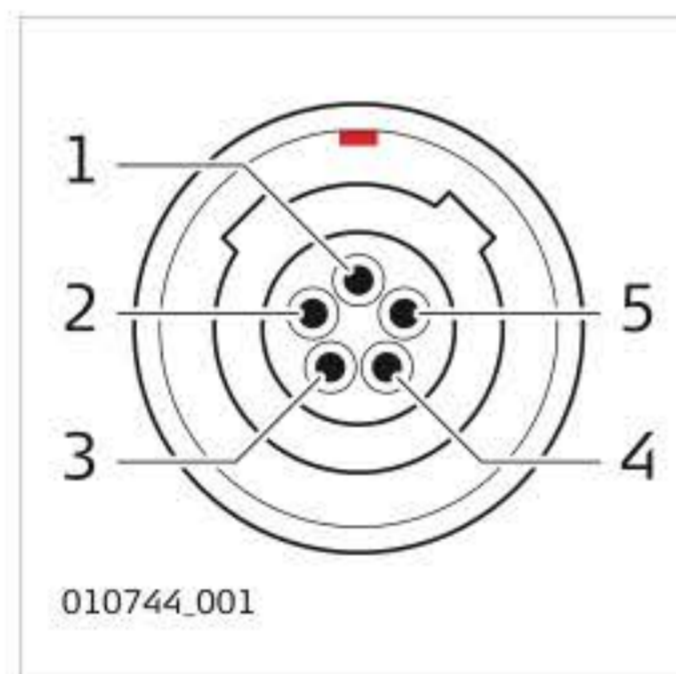

Pin	Name	Function
1	PWR_IN	Power-In, 24 V
2	NC	Do not connect
3	GND	Ground
4	GND	Ground
5	PWR_IN	Power-In, 24 V

5.5 Environmental Specifications

Environmental specifications

Temperature

Type	Operating temperature [°C]	Storage temperature [°C]
Artec Ray II	-5 to +40	-40 to +70



Extended low temperature operation is possible down to -10 °C if internal temperature is at or above -5 °C when powered on. When the device is operated in the extended low temperature range, redundant measurements and plausibility checks are recommended to verify the measurement results.



Internal temperature can be checked in the System Information screen on the device. Refer to [3.5.3 Settings](#).

Type	Operating temperature [°C]	Storage temperature [°C]
Battery	Charging: 0 °C to +50 °C Discharging: -20 °C to +60 °C	-40 to +70
Power supply	0 °C to +40 °C	-10 to +80

Protection against water, dust and sand

Type	IP class
Artec Ray II	IP54 (IEC 60529), upright ±15°/ upside down ±15° <ul style="list-style-type: none"> • Dust protected • Protection against splashing water from any direction <p>IP51 (IEC60529), in any other position</p> <ul style="list-style-type: none"> • Dust protected • Protection against dripping water
Battery	IP54 (IEC 60529) <ul style="list-style-type: none"> • Dust protected • Protection against splashing water from any direction
Power supply	Only operate in dry environments, for example in buildings and vehicles.

Pollution degree

Type	Pollution degree
Artec Ray II/ Battery	4 Electrical equipment for indoor and outdoor use.
Power supply/ Multicharger	2 Electrical equipment for office environment.

Humidity

Type	Protection
Artec Ray II/ Battery	Max 95% non-condensing.

5.5 Environmental Specifications

Lighting

Type	Conditions
Artec Ray II	Fully operational from bright sunlight to complete darkness.

Altitude

Type	Range
Artec Ray II/Battery/ Multicharger	Unrestricted
Power supply	0-2000 m

Sound level

Type	Value
Artec Ray II	< 70 db(A)

5.6 Dimensions

Dimensions

Part	Dimensions [mm] (D × W × H)	Dimensions ["] (D × W × H)
Artec Ray II laser scanner	120 × 240 × 230	4.7 × 9.4 × 9.1
Power supply	2.5 × 72.2 × 42.0	0.1 × 2.8 × 1.7
Battery	60 × 72 × 31	2.4 × 2.8 × 1.2
Transport Container for Ray II	257 × 537 × 383	10.1 × 21.1 × 15.1
Backpack	200 × 350 × 460	7.9 × 13.8 × 18.1

Part	Dimensions [mm] (Diameter)	Dimensions ["] (Diameter)
Adapter to mount an Artec Ray II on top of a heavy duty tripod	104.5 × 40	4.1 × 1.6

Artec Ray II laser scanner:



5.6 Dimensions

Adapter to mount an Artec Ray II on top of a heavy duty tripod:



5.7 Weight

Weight

Part	Weight [kg]	Weight [lbs]
Artec Ray II	5.3 nominal	11.7 nominal
Power supply	0.86	1.9
Battery	0.34	0.7
Transport Container for Ray II (without scanner and accessories)	3.67	8.1
Backpack for Ray II	1.79	3.9

5.8 Accessories

Scope of delivery

Included standard accessories:

- 1x Transport Container for Ray II
- 1x Multicharger for Ray II
- 4x Battery for Ray II
- 2x 256 Gb USB flash drive for Ray II
- 1x Rain Cover for Ray II
- 1x Quick Start Guide
- 1x Tripod adapter for Ray II
- 1x Calibration certificate digital access via online registration

Additional accessories

- Battery for Ray II
- Backpack for Ray II
- Power supply for Ray II

5.9 Conformity to National Regulations

5.9.1 Artec Ray II

Labelling Artec Ray II



16140.005

Model: Artec Ray II Art.No.: 907000
Equip.No.: 12345678 S.No.: 1234567
ARTEC EUROPE S.à.r.l., 1748 Senningerberg, Luxembourg
Manufactured: MM.20YY, Made in Switzerland
Power: 24V = / 75W max.  R 007 AC0271 
WLAN PW: 12345678

UK CA **CE**   R-C-SXT-SX-PCEAN2

This device contains:
FCC ID: N6C-SXPCEAN2 **IP54**
IC: 4608A-SPCEAN2



Complies with 21 CFR 1040.10 and 1040.11 except for conformance with IEC 60825-1 Ed. 3., as described in Laser Notice No. 56, dated May 8, 2019.
This device complies with Part 15 of the FCC Rules. Operation is subject to the following two conditions:
(1) this device may not cause harmful interference, and
(2) this device must accept any interference received, including interference that may cause undesired operation.

IEC 60825-1: 2014

Labelling Battery



Model/型号: AEB364 Art. No.: 987908
Rechargeable Li-ion Battery 二次锂离子電池組
Nominal Voltage: 10.8 V 额定电压 3INR 19/66-2
Rated Capacity: 6.9Ah / 74.52Wh 12 A R3CXXX
Manufactured For: ARTEC EUROPE S.à.r.l., 1748 Senningerberg, Luxembourg
Manufactured by: Huzhou Longji Electronics Co., Ltd. MFD.: XXXXX Made in China

UK CA    전지
XXXXXXXX-XXXXXX
A/S: +82 31 820 6252
中國製造

*This device complies with part 15 of the FCC Rules. Operation is subject to the following two conditions:
(1) This device may not cause harmful interference, and
(2) This device must accept any interference received, including interference that may cause undesired operation.*

CUL US
MH29443

Labelling Multicharger



Type 型号: AKL341 Art.No.: 987921
Battery Charger 电池充电器 전기충전기
Input, 输入, 入力: 100-240V ~ / 50-60Hz / 1.5A max. / 175 VA
24 Vem / 2.8 A max.
Output, 产出, 出力: 16.8 Vem / 3 A max.
ARTEC EUROPE S.à.r.l.
1748 Senningerberg, Luxembourg
Manufacturer, 製造商, 제조사: HUZHOU LONGJI ELECTRONICS Co., Ltd
工厂, 工場: 湖州捷基电子有限公司
Made in China, 中国製造, 중국에서 만든



UL US LISTED **CE** **UK CA**   
PS E   
XXXXXXXX-XXXXXX
XXXXXXXX-XXXXXX



*This device complies with part 15 of the FCC Rules. Operation is subject to the following two conditions:
(1) This device may not cause harmful interference, and
(2) This device must accept any interference received, including interference that may cause undesired operation.*

0000001



Labelling Power supply



GlobTek, Inc.  
P/N: 354642 TYPE GEV232
Fuente de alimentación de 75W para el scanner Artec Ray II
Mediatori di alimentazione per scanner Artec Ray II
MP Multiplataforma de alimentación. 75 W 75W050005.030000000000
Model: 354642 / 354642-1 / 354642-2
MFG: 10/2019
REV: 1.0
OUTPUT: Salida: 24V / 3A / 75W

UL US **CE** **UK CA**   
PS E   
XXXXXXXX-XXXXXX
XXXXXXXX-XXXXXX

*This device complies with part 15 of the FCC Rules. Operation is subject to the following two conditions:
(1) This device may not cause harmful interference, and
(2) This device must accept any interference received, including interference that may cause undesired operation.*

UK CA **CE**   
Part 15 of the FCC Rules
Part 15 of the FCC Rules
30
MADE IN CHINA 中国製造 中國製造

5.9.1 Artec Ray II

Frequency band

Type	Frequency band
WLAN 2.4 GHz	2400–2483.5 MHz

Output power

Type	Output power
WLAN 2.4 GHz	Max. 80 mW, at each of 2 antenna channels

Antenna

Type	Antenna	Gain [dBi]
WLAN 2.4 GHz	Integrated antennas 2×2 MIMO	0 dBi

EU



Hereby, Artec 3D declares that the products Battery and Multicharger for Ray II are in compliance with the essential requirements and other relevant provisions of the applicable European Directives. For the full text of the EU declaration of conformity, please reach out to the to the [Artec 3D Support Team](#).

EU



Hereby, Artec 3D declares that the radio equipment type Artec Ray II is in compliance with Directive 2014/53/EU and other applicable European Directives. For the full text of the EU declaration of conformity, please reach out to the to the [Artec 3D Support Team](#).

USA

FCC ID: N6C-SXPCEAN2

FCC Part 15 B/C

This device complies with part 15 of the FCC Rules. Operation is subject to the following two conditions:

1. This device may not cause harmful interference.
2. This device must accept any interference received, including interference that may cause undesired operation.

This equipment has been tested and found to comply with the limits for a Class B digital device, pursuant to part 15 of the FCC Rules.

These limits are designed to provide reasonable protection against harmful interference in a residential installation.

This equipment generates, uses, and can radiate radio frequency energy and, if not installed and used in accordance with the instructions, it may cause harmful interference to radio communications.

However, there is no guarantee that interference does not occur in a particular installation.

If this equipment does cause harmful interference to radio or television reception, which can be determined by turning the equipment off and on, the user is encouraged to try to correct the interference by one or more of the following measures:

- Reorient or relocate the receiving antenna.
- Increase the separation between the equipment and the receiver.
- Connect the equipment into an outlet on a circuit different from that to which the receiver is connected.
- Consult the dealer or an experienced radio/TV technician for help.

5.9.1 Artec Ray II

Canada

CAN ICES-003 Class B/NMB-003 Class B
IC: 4608A-SPCEAN2

Canada Compliance Statement

This device contains license-exempt transmitter(s)/receiver(s) that comply with Innovation, Science and Economic Development Canada's license-exempt RSS(s). Operation is subject to the following two conditions:

1. This device may not cause interference.
2. This device must accept any interference, including interference that may cause undesired operation of the device.

Canada Déclaration de Conformité

L'émetteur/récepteur exempt de licence contenu dans le présent appareil est conforme aux CNR d'Innovation, Sciences et Développement économique Canada applicables aux appareils radio exempts de licence. L'exploitation est autorisée aux deux conditions suivantes :

1. L'appareil ne doit pas produire de brouillage.
 2. L'appareil doit accepter tout brouillage radioélectrique subi, même si le brouillage est susceptible d'en compromettre le fonctionnement.
-

Japan

- This device is granted pursuant to the Japanese Radio Law (電波法).
 - This device should not be modified (otherwise the granted designation number will become invalid).
-

Others

The conformity for countries with other national regulations has to be approved prior to use and operation.



Disposal of Electrical and Electronic Equipment in Private Households

In the European Union, Norway, Iceland and Liechtenstein: This symbol on the product, or in the manual and in the warranty, and/or on its packaging indicates that this product shall not be treated as household waste. Instead it should be taken to an applicable collection point for the recycling of electrical and electronic equipment.

Changes or modifications not expressly approved by Artec 3D for compliance could void the user's authority to operate the equipment.

Australia/New Zealand



The Regulatory Compliance Mark (RCM) shows that a product complies with the relevant requirements in Australia and New Zealand.

5.9.2 Dangerous Goods Regulations

Dangerous Goods Regulations

Many products of Artec 3D are powered by Lithium batteries.

Lithium batteries can be dangerous under certain conditions and can pose a safety hazard. In certain conditions, Lithium batteries can overheat and ignite.



When carrying or shipping your Artec product with Lithium batteries onboard a commercial aircraft, you must do so in accordance with the IATA Dangerous Goods Regulations.



Artec 3D has developed Guidelines on “How to carry Artec products” and “How to ship Artec products” with Lithium batteries. Before any transportation of an Artec product, we ask you to consult these guidelines on our web page ([IATA Lithium Batteries](#)) to ensure that you are in accordance with the IATA Dangerous Goods Regulations and that the Artec products can be transported correctly.



Damaged or defective batteries are prohibited from being carried or transported onboard any aircraft. Therefore, ensure that the condition of any battery is safe for transportation.

6 Software License Agreement/Warranty

International Limited Warranty

This product is subject to the terms and conditions set out in the International Limited Warranty which you can review [here](#) or collect from your Artec 3D distributor.

Software License Agreement

Scanning data from Artec Ray II can be processed and saved using the Artec Studio 18 software, which needs to be purchased separately and does not come with the scanner. This software is protected by copyright and other laws, and its usage is defined and regulated by the Artec Europe End User License Agreement (EULA), which covers various aspects such as, but not limited to, License Grant and Restrictions, Export Restrictions, Disclaimer of Warranties, and other information. Please ensure that at any time you fully comply with the terms and conditions of the Artec Europe End User License Agreement (EULA), which is provided along with all products. For the full text of the the Artec Europe End User License Agreement (EULA), please reach out to the [Artec 3D Support Team](#).

You must not install or use the software unless you have read and accepted the terms and conditions of the Artec Europe End User License Agreement (EULA). The installation or use of the software or any part thereof, is deemed to be an acceptance of all the terms and conditions stated in the License Agreement. For any inquiries regarding the acquisition of Artec Software, please contact our [Sales team](#).

© 2024 ARTEC EUROPE S.à r.l.

4 Rue Lou Hemmer, L-1748 Senningerberg, Luxembourg

www.artec3d.com